

DRV601EVM

This user's guide describes the operation of the DRV601EVM stereo line driver evaluation module and provides measurement data and design information such as the schematic, bill of materials, and printed-circuit board layout.

Contents

1	Overview	2
2	Quick Setup Guide.....	3
3	Shutdown	5
4	Component Selection	5
5	Layout Recommendations	7
6	DRV601EVM Performance	8
7	Related Documentation from Texas Instruments	19
8	Design Documentation	19

List of Figures

1	DRV601EVM	2
2	DRV601 Functional Block Diagram	3
3	DRV601EVM Physical Structure.....	3
4	Power-Up/Down Sequence.....	5
5	Second-Order, Active Low-Pass Filter	6
6	THD+N vs Voltage (600 Ω).....	9
7	THD+N vs Voltage (600 Ω).....	9
8	THD+N vs Voltage (100-k Ω load)	10
9	THD+N vs Voltage (100- Ω load) Linear Scale	10
10	THD+N vs Voltage (600- Ω Load)	11
11	THD+N vs Voltage (100-k Ω Load)	11
12	THD+N vs Frequency (600- Ω Load).....	12
13	THD+N vs Frequency (600- Ω Load) Using X7R Input Capacitors	12
14	FFT Spectrum With –60-dBFS Tone	13
15	Idle Noise FFT Spectrum (BTL)	13
16	Channel Separation.....	14
17	Channel Separation, 10x Lower Feedback Impedance	15
18	Frequency Response	15
19	Phase Response	16
20	Pop/Click (Enable)	17
21	Pop/Click (Disable).....	18
22	DRV601EVM PCB Component Placement Top.....	21
23	PCB Top Layer	21
24	PCB Bottom Layer	22

List of Tables

1	DRV601 Features.....	2
2	Recommended Supply Voltage	5
3	DRV601EVM Specification	6
4	General Test Specifications	8

PurePath Digital, DirectPath, FilterPro are trademarks of Texas Instruments.

5	Electrical Data	8
6	Audio Performance	8
7	Physical Specifications	8
8	DRV601EVM Parts List.....	20
9	PCB Specifications	20

1 Overview

The DRV601EVM customer evaluation module (EVM) demonstrates the integrated circuits DRV601RTJ from Texas Instruments (TI).

The DRV601 is a stereo line driver designed to allow the removal of the DC-blocking capacitors for reduced component count and cost. The DRV601 is ideal for single-supply electronics where size and cost are critical design parameters ().

The DRV601 is capable of driving 2 Vrms into a 600-Ω load at 3.3-V supply. The DRV601 has external gain-setting resistors, that support a gain range of -1 V/V to -10 V/V and line outputs that have ±8 kV IEC ESD protection. The DRV601 has independent shutdown control for the left and right audio channels.

This EVM is configured with two RCA phone input connectors and two RCA phone output connectors. Power supply is connected via a two-pin 2,54-mm pin header.

The EVM is configured with a gain of -2 V/V.

Table 1. DRV601 Features

KEY PARAMETERS	
Supply Voltage	1.8 V to 4.5 V
Number of Channels	2
Load Impedance	Minimum 600 Ω
Output Voltage	2 Vrms / 600 Ω < 0.005% THD
DYR	> 108 dB
Gain	-2 V/V

This EVM is designed for evaluating applications such as A/V receivers, DVD receivers, DVD minicomponent systems, home theater in a box (HTIB) designs, or set-top boxes.

This document covers EVM specifications, audio performance and power efficiency measurements graphs, and design documentation that includes schematics, parts list, layout, and mechanical design.

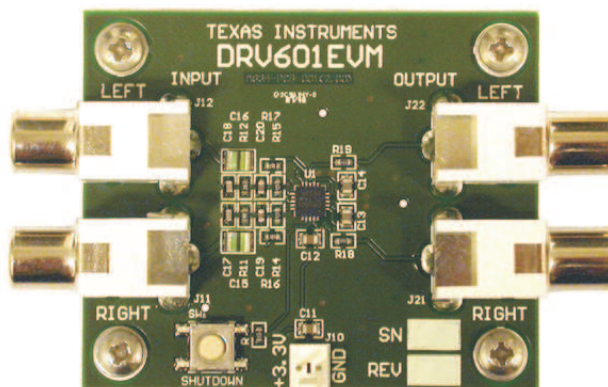

Figure 1. DRV601EVM

Gerber (layout) files are available at the [TI Web site](#).

1.1 DRV601EVM Features

- Two-channel evaluation module, a double-sided, plated-through printed-circuit board (PCB) layout.
- 2- V_{RMS} line output
- Output capacitor-less.
- Shutdown button

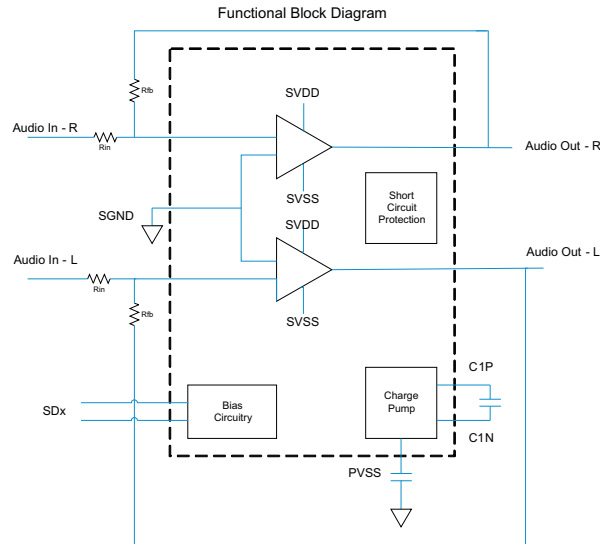

Figure 2. DRV601 Functional Block Diagram

1.2 PCB Key Map

The physical structure of the DRV601EVM is shown in [Figure 3](#).

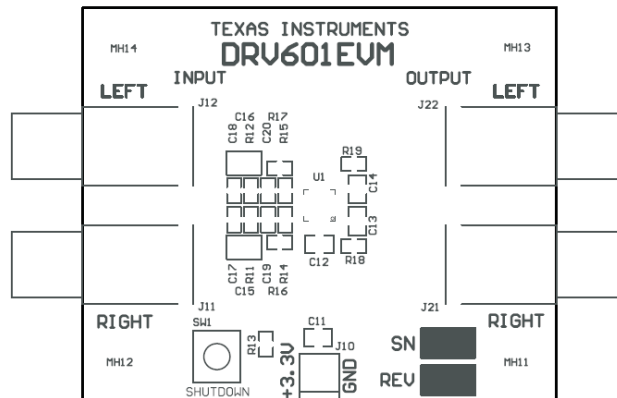

Figure 3. DRV601EVM Physical Structure

2 Quick Setup Guide

This section describes the DRV601EVM board in regards to power supply and system interfaces. It provides information regarding handling and unpacking, absolute operating conditions, and a description of the factory default switch and jumper configuration.

The following is a step-by-step guide to configuring the DRV601EVM for device evaluation.

2.1 Electrostatic Discharge Warning

Many of the components on the DRV601EVM are susceptible to damage by electrostatic discharge (ESD). Customers are advised to observe proper ESD handling precautions when unpacking and handling the EVM, including the use of a grounded wrist strap at an approved ESD workstation.

CAUTION

Failure to observe ESD handling procedures may result in damage to EVM components.

2.2 Unpacking the EVM

On opening the DRV601EVM package, ensure that the following items are included:

- 1 DRV601EVM board with one DRV601RTJ
- 1 pc. PurePath Digital™ CD-ROM

If either of these items is missing, contact the Texas Instruments Product Information Center nearest you to inquire about a replacement.

2.3 Power Supply Setup

To power up the EVM, one power supply is needed. The power supply is connected to the EVM using a 2-pin, 2,54-mm pin header, J10.

Table 2. Recommended Supply Voltage

Description	Voltage Limitations	Current Requirement	Cable
Power supply	1.8 V to 4.5 V	0.3 A	

CAUTION

Applying voltages above the limitations given in [Table 2](#) may cause permanent damage to your hardware.

3 Shutdown

For minimum click and pop during power on and power off, the shutdown pin should be kept low. The preferred power-up/down sequence is shown in [Figure 4](#).

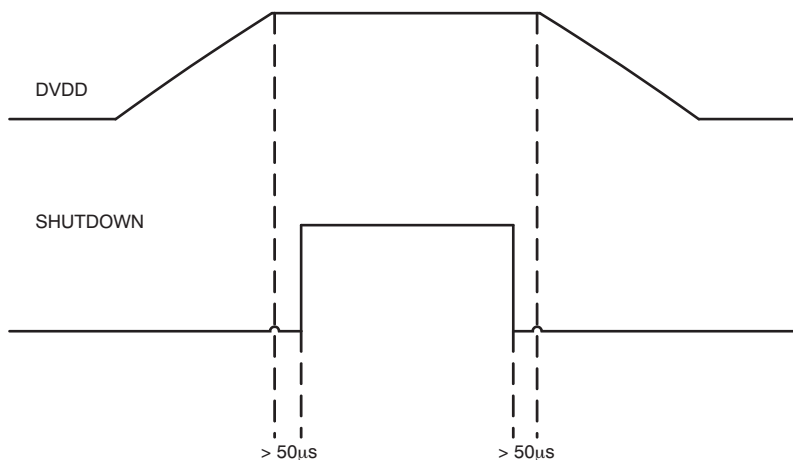

Figure 4. Power-Up/Down Sequence

4 Component Selection

4.1 Charge Pump

The charge pump flying capacitor, C13, serves to transfer charge during the generation of the negative supply voltage. The PVSS capacitor must be at least equal to the charge pump capacitor in order to allow maximum charge transfer. Low ESR capacitors are an ideal selection, and a value of 1 μ F is typical. Capacitor values smaller than 1 μ F can be used, but the maximum output can be reduced. It is therefore recommended to validate the design with thorough testing.

4.2 Decoupling Capacitors

The DRV601 is a DirectPath™ line driver amplifier that requires adequate power supply decoupling to ensure that the noise and total harmonic distortion (THD) are low. A good low equivalent-series-resistance (ESR) ceramic capacitor, C12, typical 1 μ F, placed as close as possible to the device V_{DD} leads works best. Placing this decoupling capacitor close to the DRV601 is important for the performance of the amplifier. For filtering lower frequency noise signals, a 10- μ F or greater capacitor placed near the audio amplifier also helps, but is not required in most applications because of the high PSRR of this device.

The charge pump circuit does apply ripple current on the V_{DD} line, and a LC or RC filter may be needed if noise-sensitive audio devices share the V_{DD} supply.

4.3 Supply Voltage Limiting at 4.5 V

The DRV601 has a build-in charge pump which serves to generate a negative rail for the line driver. Because the line driver operates from a positive and negative voltage supply, circuitry has been implemented to protect the devices in the amplifier from an overvoltage condition. Once the supply is above 4.5 V, the DRV601 can shut down in an overvoltage protection mode to prevent damage to the device.

4.4 Using the DRV601 as a Second-Order Low-Pass Filter

Many of the audio DACs used today require an external low-pass filter, to remove band noise. This is possible with the DRV601, and the EVM is configured as a 40-kHz second-order, active Butterworth filter. The topology chosen is the MFB Single-Ended. Further, the DRV601 needs a ac-coupling capacitor to remove dc-content from the source.

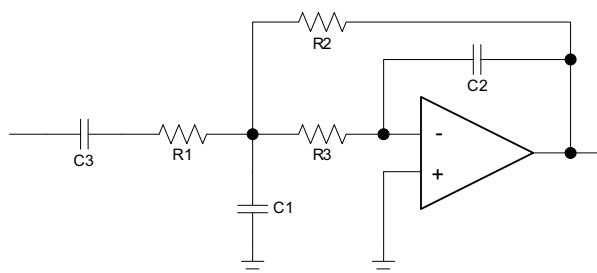

Figure 5. Second-Order, Active Low-Pass Filter

The component values can be calculated with the help of the TI FilterPro™ program available on:

<http://focus.ti.com/docs/toolsw/folders/print/filterpro.html>

In Table 3, various proposals for the filter and gain settings can be found.

Table 3. DRV601EVM Specification

Gain	High Pass	Low Pass	C1	C2	C3	R1	R2	R3
-1 V/V	16 Hz	40 kHz	100 pF	680 pF	1 μ F	10 kR	10 kR	24 kR
-1.5 V/V	19 Hz	40 kHz	68 pF	680 pF	1 μ F	8.2 kR	12 kR	30 kR
-2 V/V	11 Hz	40 kHz	33 pF	330 pF	1 μ F	15 kR	30 kR	47 kR
-2 V/V	11 Hz	30 kHz	47 pF	470 pF	1 μ F	15 kR	30 kR	43 kR
-3.33 V/V	12 Hz	40 kHz	33 pF	470 pF	1 μ F	13 kR	43 kR	43 kR
-10 V/V	15 Hz	30 kHz	22 pF	1 nF	2.2 μ F	4.7 kR	47 kR	27 kR

The resistor values should be low value to get low noise, but should be high value to get a small size ac-coupling capacitor. With the proposed values, 15k, 30k, and 47k, a DYR of 105 dB can be achieved with a small 1- μ F input ac-coupling capacitor.

5 Layout Recommendations

5.1 Exposed Pad on the DRV601RJT Package

The exposed metal pad on the DRV601RTJ package can be soldered to a pad on the PCB in order to improve reliability. The pad on the PCB should be allowed to float and not be connected to ground or power. Connecting this pad to power or ground prevents the device from working properly because it is connected internally to PVSS.

5.2 SGND and PGND Connections

The SGND and PGND pins of the DRV601 must be routed separately back to the decoupling capacitor in order to provide proper device operation. If the SGND pins are connected directly to each other, the part functions without risk of failure, but the noise and THD performance can be reduced.

6 DRV601EVM Performance

This section provides general test specifications, electrical data, audio performance data, and physical specifications.

Table 4. General Test Specifications⁽¹⁾

GENERAL TEST SPECIFICATIONS		NOTES
Supply Voltage	3.3 V	
Load Impedance	600 Ω	
Input Signal	1-kHz Sine	
Measurement Filter	AES17	

⁽¹⁾ These test conditions are used for all tests, unless otherwise specified.

Table 5. Electrical Data⁽¹⁾

ELECTRICAL DATA SPECIFICATIONS		NOTES/CONDITIONS
Output Voltage, 600 Ω	2.2 Vrms	1 kHz, unclipped (< 1% THD), $T_A = 25^\circ\text{C}$
Output Voltage, 100 k Ω	2.3 Vrms	1 kHz, unclipped (< 1% THD), $T_A = 25^\circ\text{C}$
Supply Current	< 10 mA	1 kHz, 2 m Vrms output voltage
Supply Current	< 20 mA	1 kHz, 2 m Vrms output voltage into 600 Ω

⁽¹⁾ All electrical and audio specifications are typical values.

Table 6. Audio Performance

AUDIO PERFORMANCE			NOTES/CONDITIONS
THD+N, 600 Ω	0.02 Vrms	< 0.099 %	1 kHz (Noise-limited)
THD+N, 600 Ω	0.2 Vrms	< 0.009 %	1 kHz (Noise-limited)
THD+N, 600 Ω	2 Vrms	< 0.006 %	1 kHz
THD+N, 100 k Ω	0.02 Vrms	< 0.099 %	1 kHz (Noise-limited)
THD+N, 100 k Ω	0.2 Vrms	< 0.009 %	1 kHz (Noise-limited)
THD+N, 100 k Ω	2 Vrms	< 0.005 %	1 kHz
Dynamic Range		> 105 dB	Ref: 2 Vrms, A-weighted, AES17 filter
Noise Voltage		< 12 μ Vrms	A-weighted, AES17 filter
DC Offset		< 5m mV	No signal, 600- Ω load
Channel Separation		> 97 dB	1 kHz, 2 Vrms
Frequency Response: 20 Hz to 20 kHz		+0.5/-1 dB	2 Vrms/600 Ω

Table 7. Physical Specifications⁽¹⁾

PHYSICAL SPECIFICATIONS		NOTES/CONDITIONS
PCB Dimensions	50 x 60 x 25	Width x Length x Height (mm)
Total Weight	35g	Components + PCB + Mechanics

⁽¹⁾ All electrical and audio specifications are typical values.

6.1 THD+N vs Voltage (600-Ω Load)

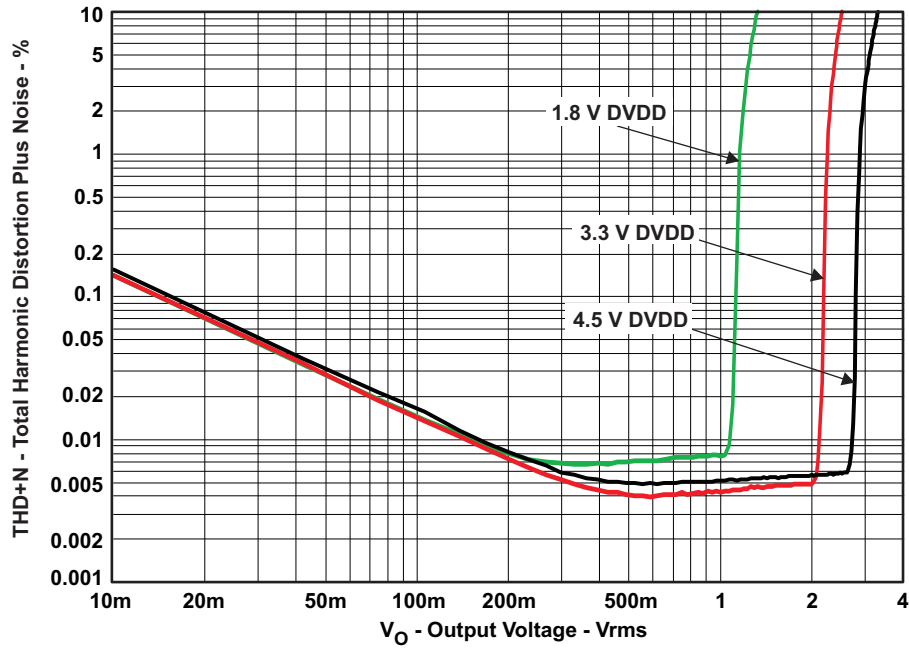

Figure 6. THD+N vs Voltage (600 Ω)

The THD+N from 10m Vrms to approximately 0.5 Vrms is dominated by noise.

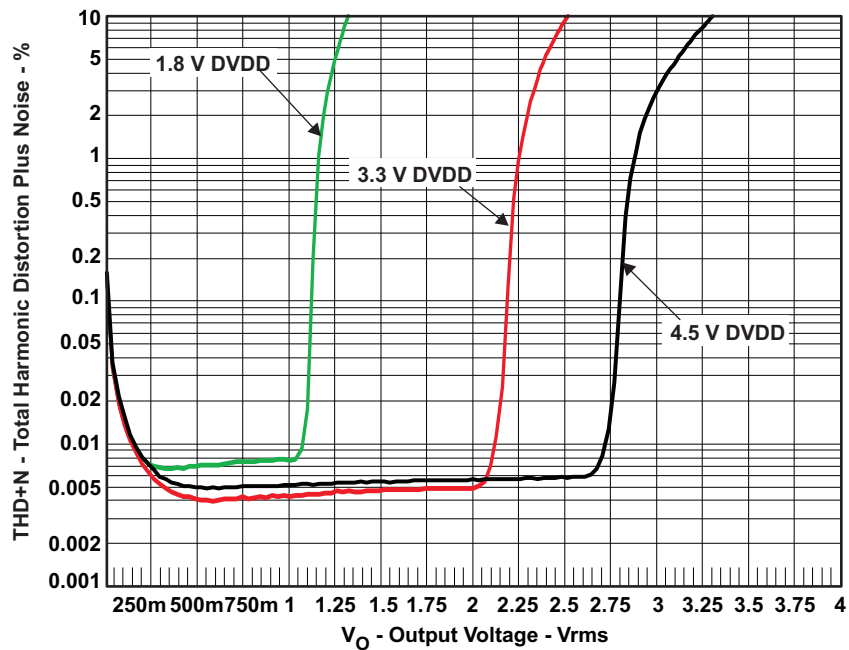

Figure 7. THD+N vs Voltage (600 Ω)

Here the THD+N versus output voltage is shown with linear scale, this makes it easier to see where clipping occurs. Clipping is often defines as THD+N=1%. For the DRV601 this is 2.25 Vrms with a 3.3-V supply and 600-Ω load.

6.2 THD+N vs Voltage (100-kΩ load)

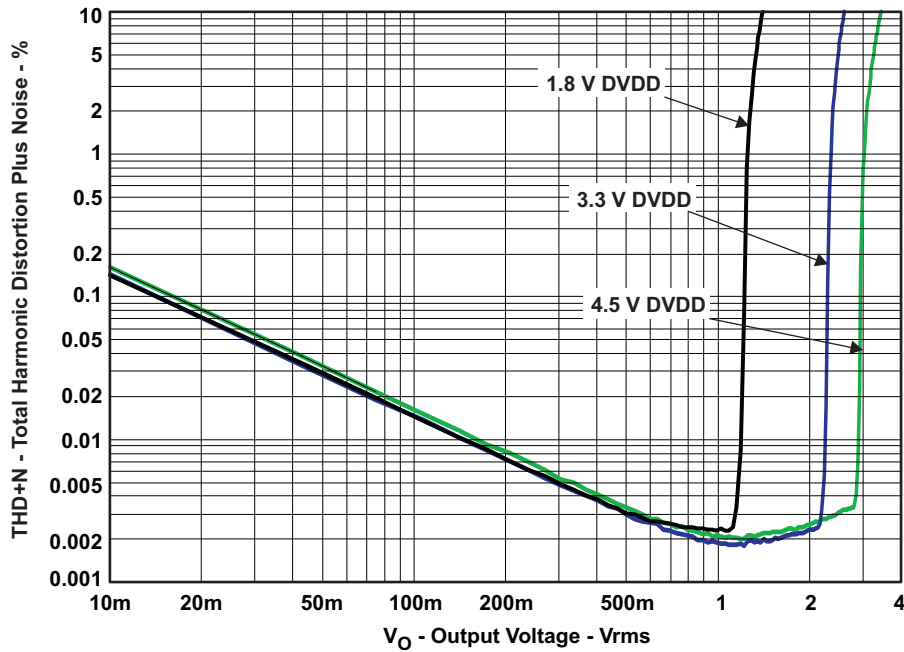

Figure 8. THD+N vs Voltage (100-kΩ load)

The THD+N in the range from 10mVrms to 1Vrms is completely dominated by noise.

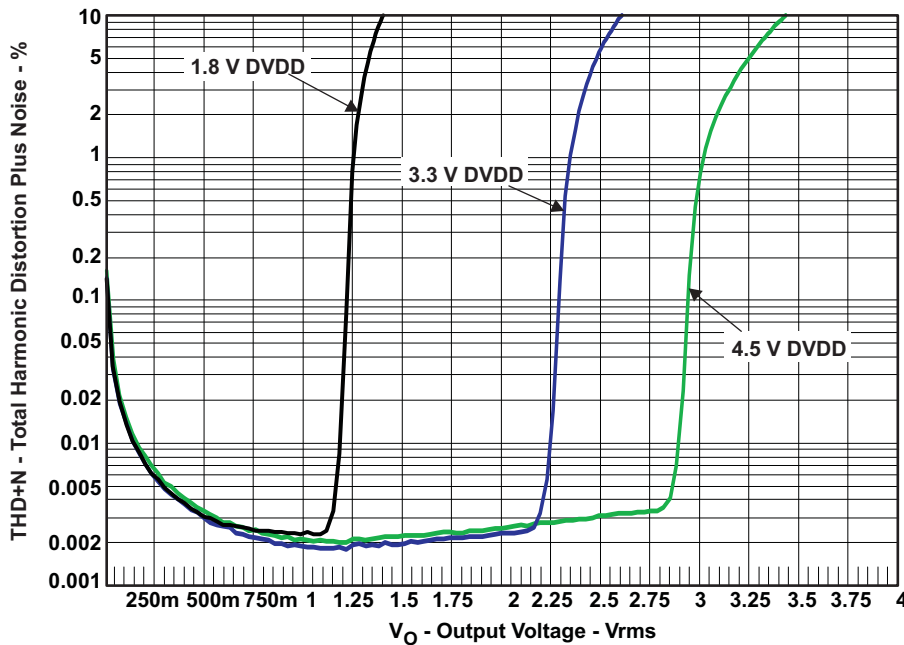

Figure 9. THD+N vs Voltage (100-Ω load) Linear Scale

Here the THD+N versus output voltage is shown with linear scale; this makes it easier to see where clipping occurs. Clipping is often defined as THD+N = 1%. For the DRV601 this is over 2.25 Vrms with a 3.3-V supply and 100-kΩ load.

6.3 THD+N vs Frequency (600R Load)

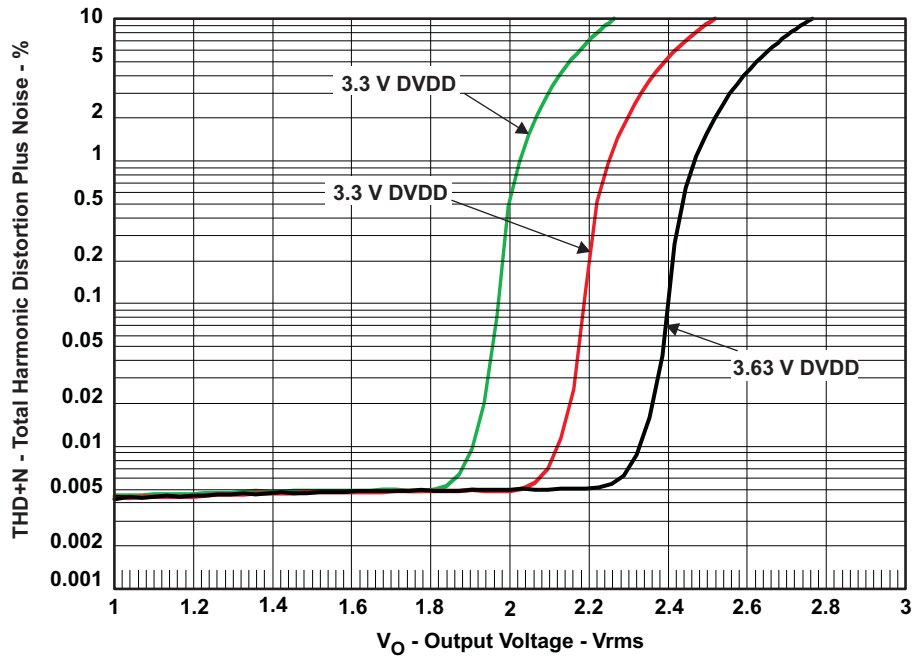

Figure 10. THD+N vs Voltage (600-Ω Load)

Here the clipping is shown with a 3.3-V supply, and $\pm 10\%$ tolerance. It shows that even with a low DVDD, 3.3 V $\pm 10\%$, the DRV601 can achieve the 2 Vrms with a THD+N less than 1%.

2 Vrms is equal to 2.848-Vpeak; that is only 142-mV drop from the 2.97-V supply

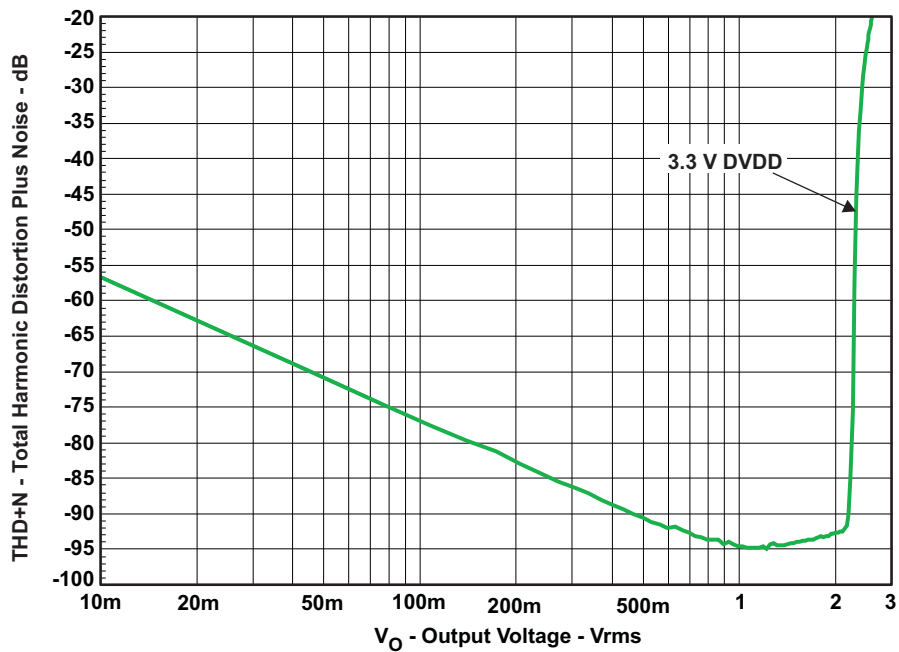

Figure 11. THD+N vs Voltage (100-kΩ Load)

With the THD+N in dB scale. 0.001% corresponds to -100 dB.

6.4 THD+N vs Frequency

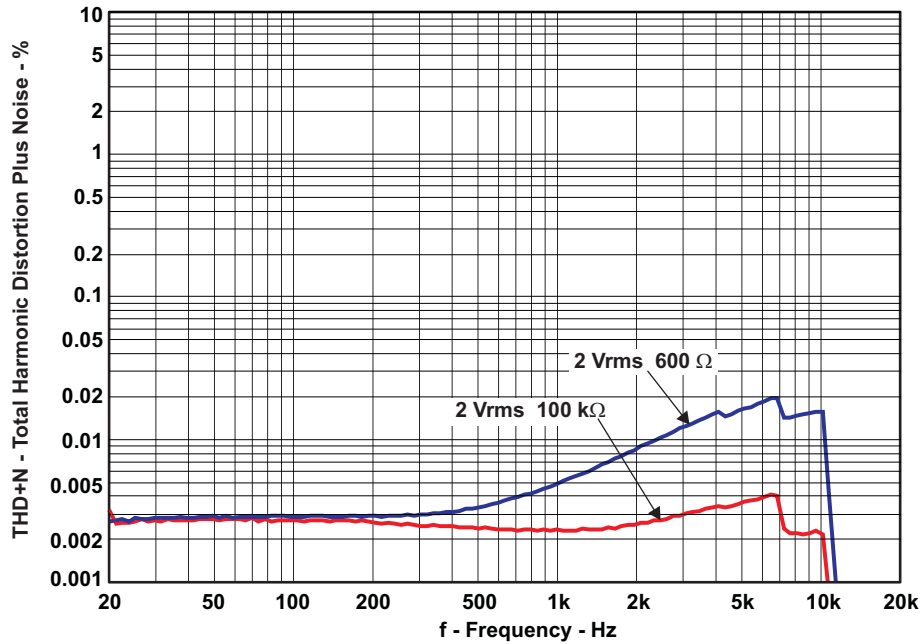

Figure 12. THD+N vs Frequency (600-Ω Load)

The DRV601EVM uses a 1-μF film capacitor for ac-coupling of the input signal. If a lower cost ceramic capacitor, like a X7R is used, higher THD at low frequencies should be expected. Y5V capacitors show even higher THD and cannot be recommended at all.

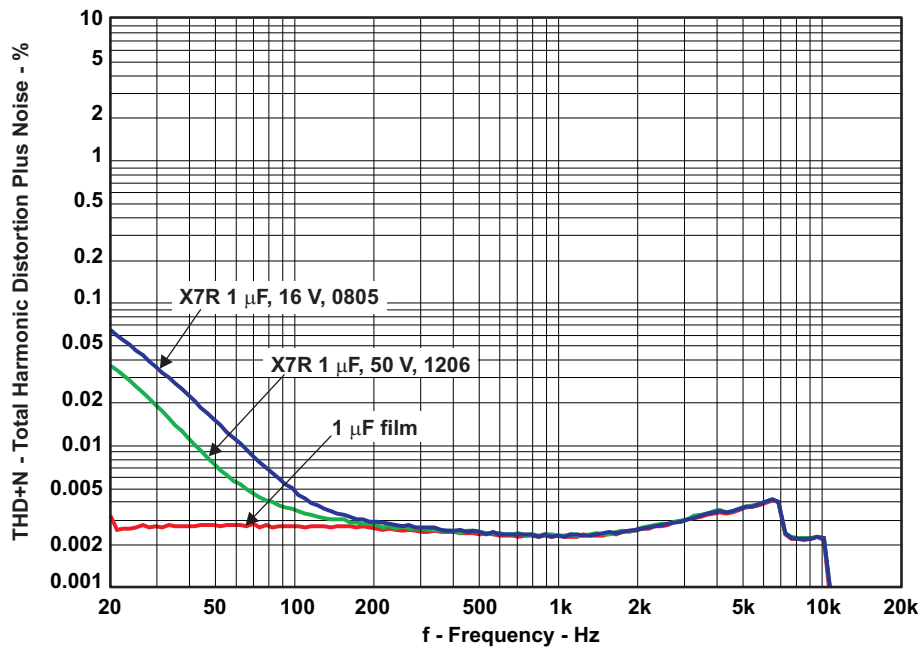

Figure 13. THD+N vs Frequency (600-Ω Load) Using X7R Input Capacitors

The X7R capacitors raise the 20-Hz THD from 0.003% to 0.04% or 0.07–20 times higher. If the cost requirements for the system demand that an inexpensive capacitor is used, then select the X7R capacitor with the highest voltage rating, as seen from the figure a 50-V X7R 1206 capacitor has 2x lower THD than a 16-V X7R 0805 capacitor.

6.5 FFT Spectrum With -60 dBFS Tone

Reference voltage is 2 Vrms. FFT size 16k.

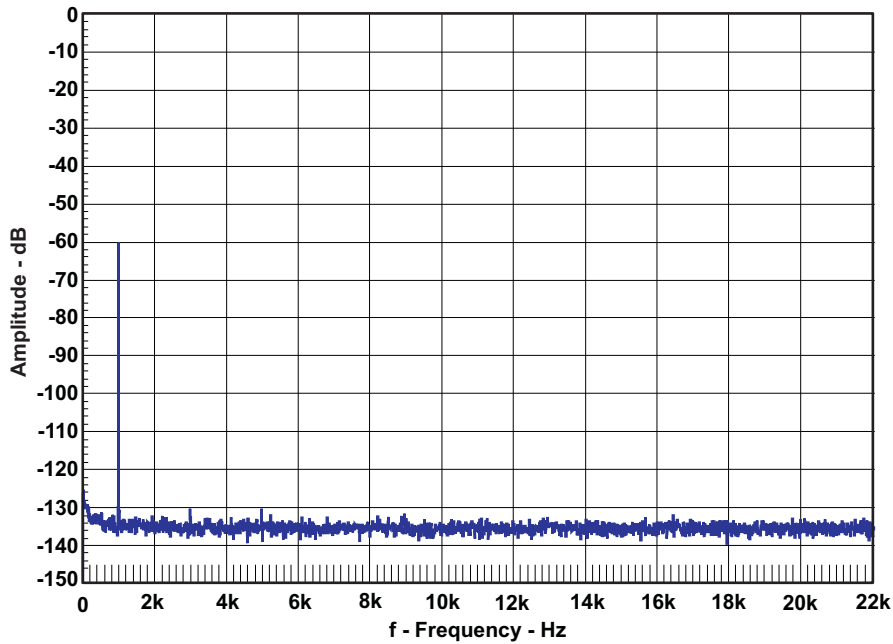

Figure 14. FFT Spectrum With -60-dBFS Tone

This spectrum corresponds to a dynamic range of 104-dB A-weighted. SNR measures to 104 dB A-weighted, <12 μ Vrms. This noise floor is dominated by the feedback resistor network impedance level. This can be improved by lowering the impedance level, a 10x lower impedance level lowers the noise floor to 110 dB, <6 μ Vrms.

6.6 Idle Noise FFT Spectrum

Reference voltage is 2 Vrms. FFT size 16k.

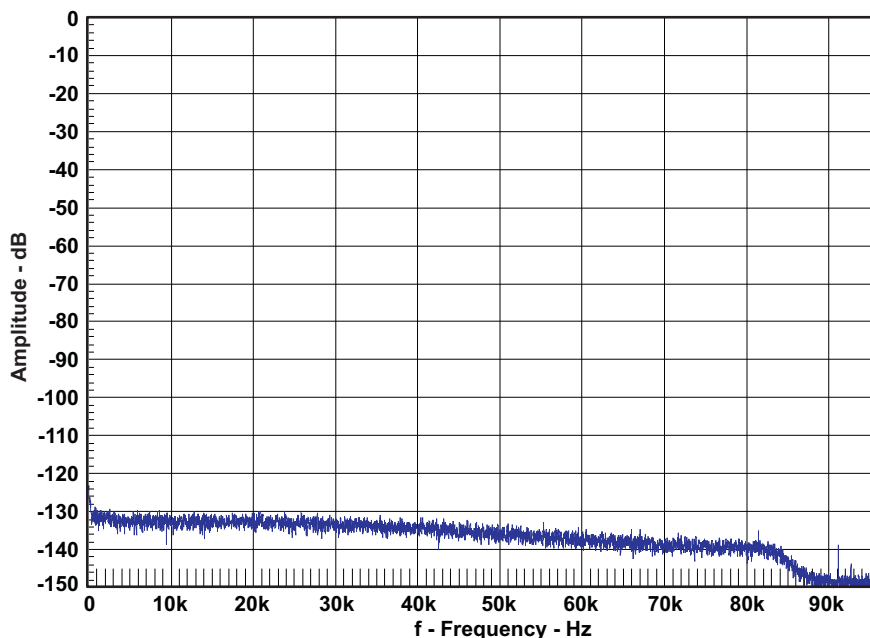

Figure 15. Idle Noise FFT Spectrum (BTL)

6.7 Channel Separation

Channel-1 output signal is 2 Vrms; channel-2 input is grounded. Reference voltage is 2 Vrms; the load is 600R.

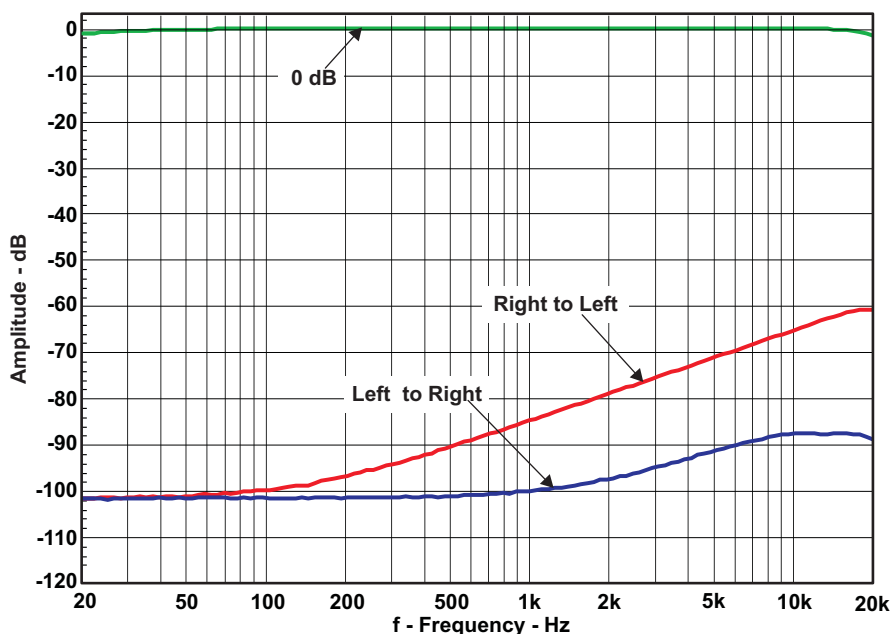

Figure 16. Channel Separation

Left-to-right cross-coupling and right-to-left cross-coupling are not exactly the same; a difference of 15 dB is seen at 1 kHz. The channel separation is more than 80 dB in both cases. The cause for the cross-coupling is the high impedance of the feedback network. If a lower cross-coupling is wanted, the feedback impedance can be lowered, this has an influence on the input coupling capacitor that needs to be equally larger and thereby adds more cost.

6.8 Frequency Response

Measurement bandwidth filter is set to 500 kHz.

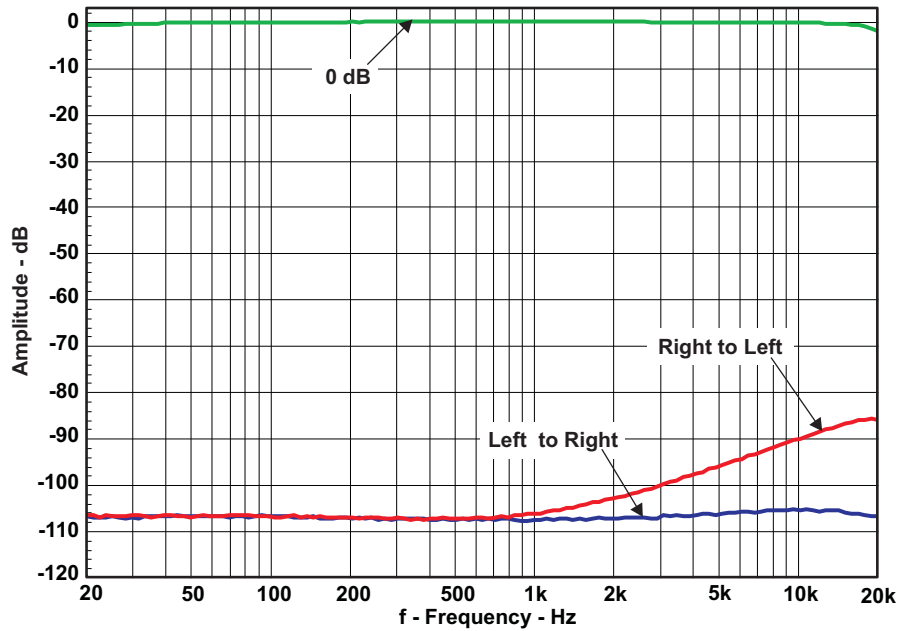

Figure 17. Channel Separation, 10x Lower Feedback Impedance

With a 10x lower impedance in the feedback network, the channel separation improved significantly and is now >100 dB at 1 kHz. The lower impedance network also improved the noise floor, and now the dynamic range is >110-dB, equal to $6\text{-}\mu\text{V}_{\text{rms}}$ noise.

The parts used are: R11=R12=1k5, R16=R17=3k0, R14=R15=4k7, C17=C18=3n3, C19=C20=330 pF, C15=C16=10 μ F ac-coupling.

Measurement bandwidth filter is set to 500 kHz.

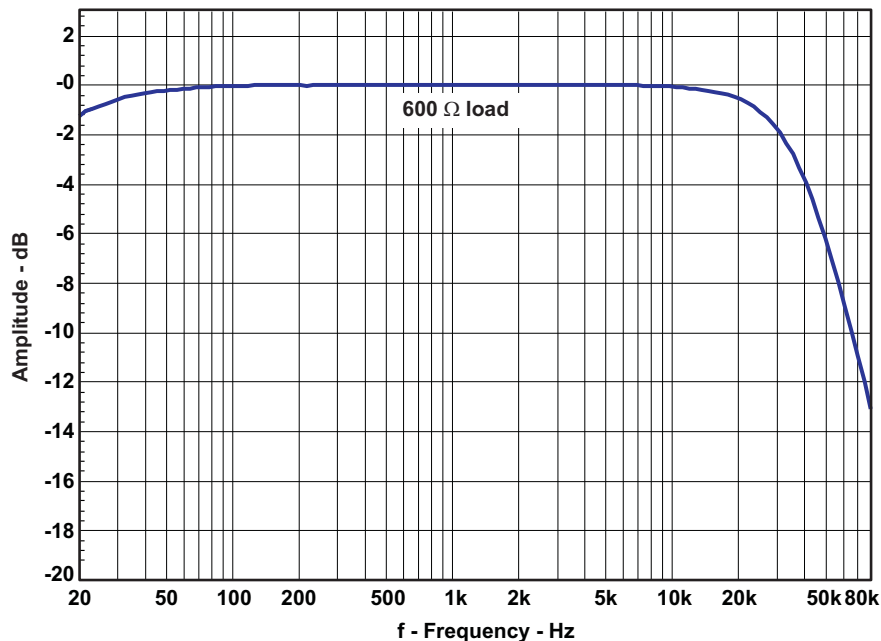

Figure 18. Frequency Response

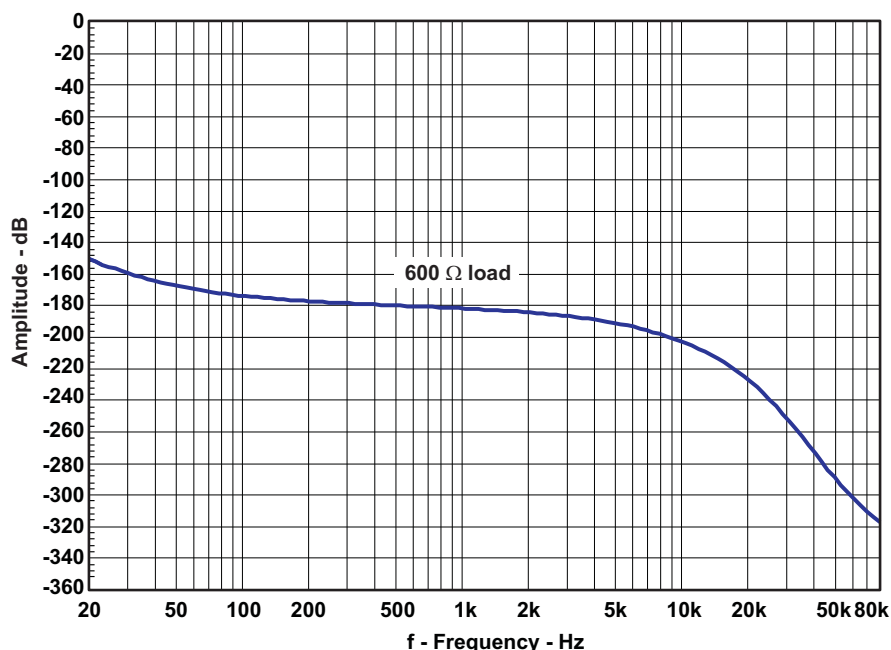

Figure 19. Phase Response

The low-frequency cutoff of 10 Hz (-3 dB) is determined by the input ac-coupling capacitor, $1 \mu\text{F}$, together with the feedback network input impedance of $15\text{k}\Omega$.

The low-pass, second-order filter implemented gives a -3 dB approximately at 35 kHz , and the response is 13 dB down at 80 kHz .

6.9 Pop/Click (Enable)

No input signal is applied. The measurement results are presented both in a time domain and in a frequency domain. The resistor load is 600Ω .

The power supply is applied, and then the shutdown signal is released. The shutdown signal is used to trigger the measuring system. For a description of the measuring technique, see the application report *Pop and Click Measuring Technique* ([SLEA044](#)).

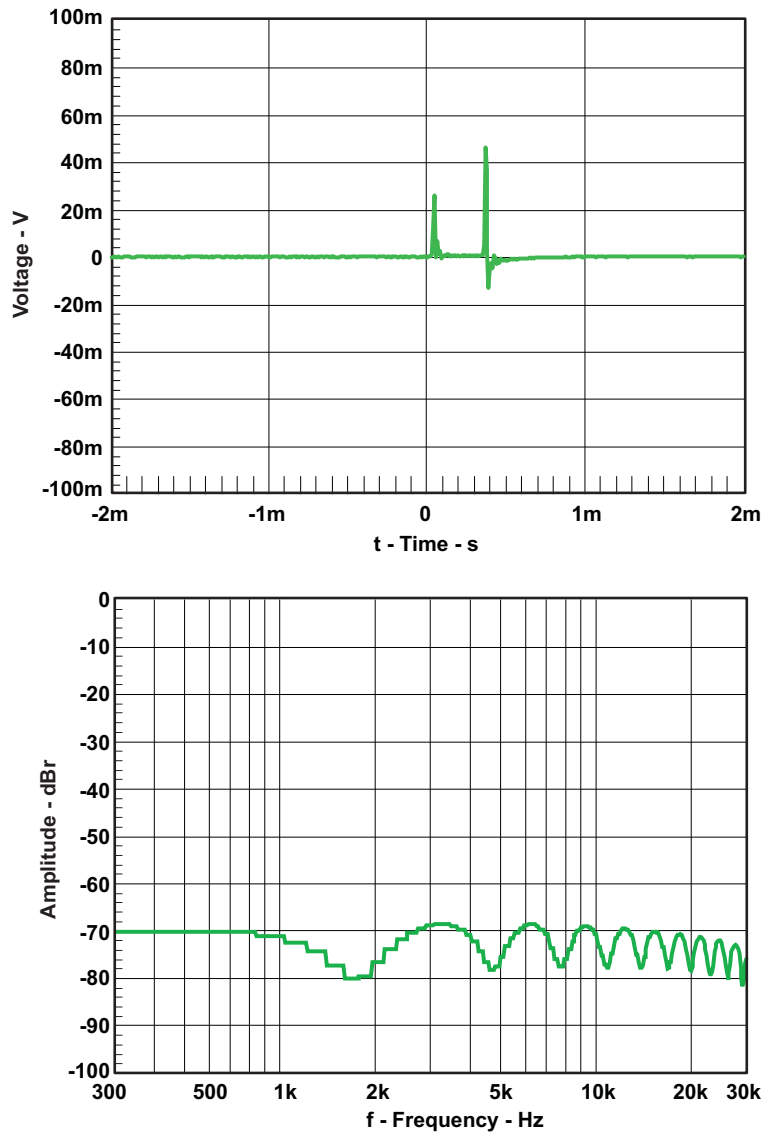

Figure 20. Pop/Click (Enable)

The DRV601 shows very low pop during enable; only two small high-frequency spikes can be seen. The measurements are made with reference to $2 V_{rms} = 0 \text{ dB}$, $2 \text{ mV} = -60 \text{ dBr}$.

6.10 Pop/Click (Disable)

No input signal is applied. The measurement results are presented both in a time domain and in a frequency domain.

No input signal applied. Load: 600Ω .

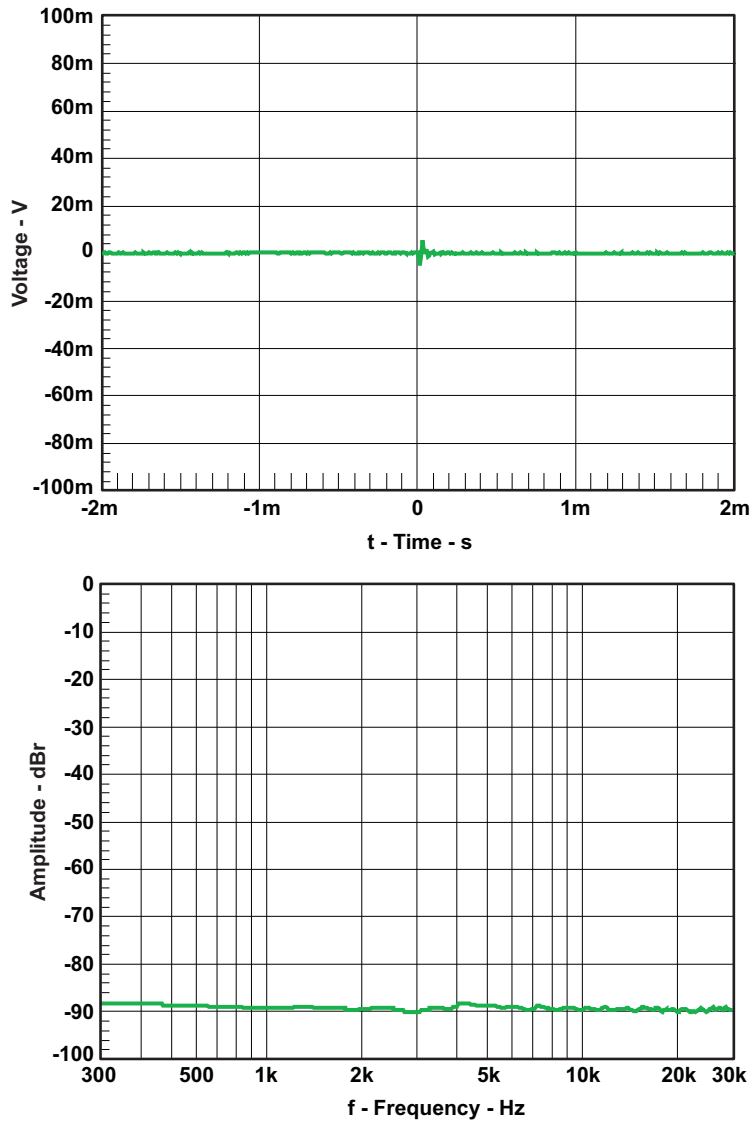

Figure 21. Pop/Click (Disable)

During power-down, the click is even lower than during power-on (enable). A very small click is seen.

7 Related Documentation from Texas Instruments

For detailed descriptions of the integrated circuits used in the design of the DRV601EVM, see data sheet *DirectPath™ Stereo Line Driver, Adjustable Gain* ([SLOS553](#)).

8 Design Documentation

This section includes a schematic for the DRV601EVM, the bill of materials, and the PCB design specifications.

8.1 DRV601EVM Schematic

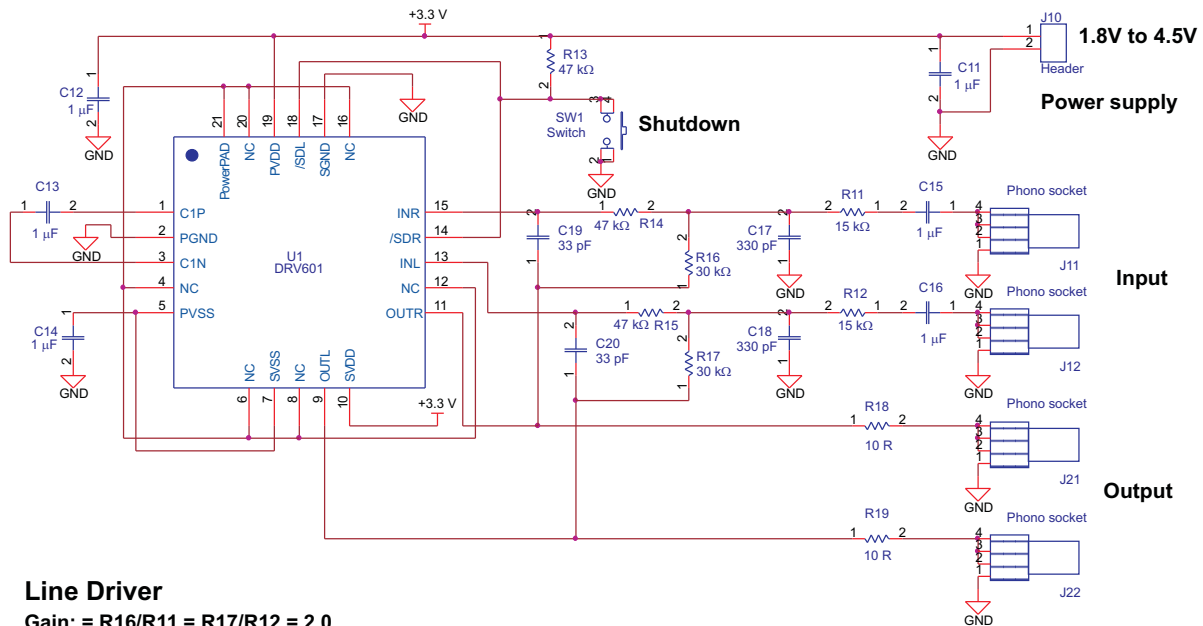

Line Driver

Gain: = $R16/R11 = R17/R12 = 2.0$

High Pass filter: $R11-C15 = R12-C16$ approx. 10Hz

Low Pass filter: 40kHz 2nd Order Butterworth

Layout note:

Do not ground the powerpad - keep it floating

Place C12-C13-C14 close to U10

Place R14-C19 close to pin 15

Place R15-C20 close to pin 13

8.2 Parts List

Table 8. DRV601EVM Parts List

Qty	Part Reference	Description	Manufacture	First Mfr P/N
4	C11 C12 C13 C14	Ceramic 1 μ F / 16V / 20% X7R 0805 Capacitor	BC Components	0805B105M160NT
2	C15 C16	Metal Film 1 μ F / 16V / 20% Polyester 1210 Capacitor	Panasonic	EPCU1C105MA5
2	C17 C18	Ceramic 330 pF / 50V / 10% NP0 0603 Capacitor	BC Components	0603N331K500NT
2	C19 C20	Ceramic 33 pF / 50V / 10% NP0 0603 Capacitor	BC Components	0603N330K500NT
1	J10	2 pins / 1 row / 2,54mm Pitch Vertical Male Friction Lock Pin Header	Molex	22-27-2021
4	J11 J12 J21 J22	Horizontal Female w. Switch Coax Phono socket	Chunfeng	RJ843-4W
1	PCB11	A834-PCB-001_2.00 / DRV601EVM Printed Circuit Board (ver. 2.00)	Printline	A834-PCB-001(2.00)
2	R11 R12	15k / 100 mW / 5% / 0603 Thick Film Resistor	Yageo	RC0603JR-0715KL
3	R13 R14 R15	47k / 100 mW / 5% / 0603 Thick Film Resistor	Yageo	RC0603JR-0747KL
2	R16 R17	30k / 100 mW / 5% / 0603 Thick Film Resistor	Yageo	RC0603JR-0730KL
2	R18 R19	10R / 100 mW / 5% / 0603 Thick Film Resistor	Yageo	RC0603JR-0710RL
1	SW1	Switch 6 mm SMD Tactile Switch	Omron	B3S-1000
1	U1	DRV601 / DirectPath™ Audio Line Driver with external gain setting. (QFN-20)	Texas Instruments	DRV601RTJT

8.3 PCB Specifications

Table 9. PCB Specifications

BOARD IDENTIFICATION	A834-PCB-001(2.00)
BOARD TYPE	Double-sided plated-through board
LAMINATE TYPE	FR4
LAMINATE THICKNESS	1,6 mm
COPPER THICKNESS	35 μ m (Include plating exterior layer)
COPPER PLATING OF HOLES	> 25 μ m
MINIMUM HOLE DIAMETER	0,3 mm
SILKSCREEN COMPONENT SIDE	White—Remove silkscreen from solder area and pre-tinned areas
SILKSCREEN SOLDER SIDE	None
SOLDER MASK COMPONENT SIDE	Green
SOLDER MASK SOLDER SIDE	Green
PROTECTIVE COATING	Solder coating and chemical silver on free copper
ELECTRICAL TEST	PCB must be electrically tested
MANUFACTURED TO	PERFAG 2E (www.perfag.dk)
APERTURE TABLE	PERFAG 10A (www.perfag.dk)
BOARD SIZE	60 mm \times 50 mm
COMMENTS	See drill information file (A834-PCB-001 (DrillDrawing).pdf)

8.4 PCB Layout

Gerber files are available on the EVM page for download.

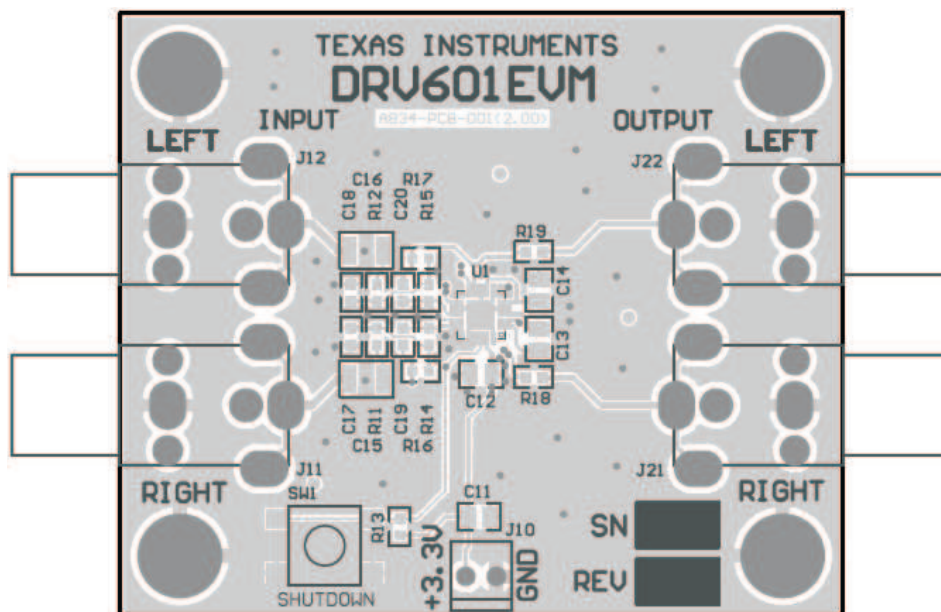

Figure 22. DRV601EVM PCB Component Placement Top

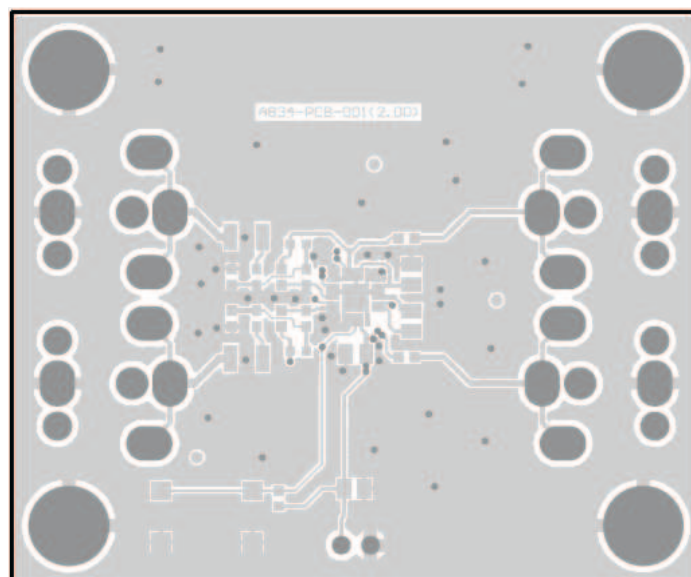

Figure 23. PCB Top Layer

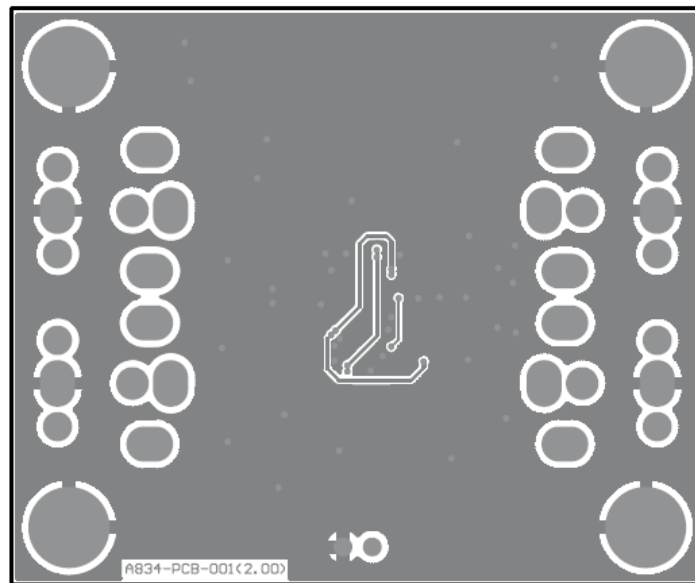

Figure 24. PCB Bottom Layer

EVALUATION BOARD/KIT IMPORTANT NOTICE

Texas Instruments (TI) provides the enclosed product(s) under the following conditions:

This evaluation board/kit is intended for use for **ENGINEERING DEVELOPMENT, DEMONSTRATION, OR EVALUATION PURPOSES ONLY** and is not considered by TI to be a finished end-product fit for general consumer use. Persons handling the product(s) must have electronics training and observe good engineering practice standards. As such, the goods being provided are not intended to be complete in terms of required design-, marketing-, and/or manufacturing-related protective considerations, including product safety and environmental measures typically found in end products that incorporate such semiconductor components or circuit boards. This evaluation board/kit does not fall within the scope of the European Union directives regarding electromagnetic compatibility, restricted substances (RoHS), recycling (WEEE), FCC, CE or UL, and therefore may not meet the technical requirements of these directives or other related directives.

Should this evaluation board/kit not meet the specifications indicated in the User's Guide, the board/kit may be returned within 30 days from the date of delivery for a full refund. **THE FOREGOING WARRANTY IS THE EXCLUSIVE WARRANTY MADE BY SELLER TO BUYER AND IS IN LIEU OF ALL OTHER WARRANTIES, EXPRESSED, IMPLIED, OR STATUTORY, INCLUDING ANY WARRANTY OF MERCHANTABILITY OR FITNESS FOR ANY PARTICULAR PURPOSE.**

The user assumes all responsibility and liability for proper and safe handling of the goods. Further, the user indemnifies TI from all claims arising from the handling or use of the goods. Due to the open construction of the product, it is the user's responsibility to take any and all appropriate precautions with regard to electrostatic discharge.

EXCEPT TO THE EXTENT OF THE INDEMNITY SET FORTH ABOVE, NEITHER PARTY SHALL BE LIABLE TO THE OTHER FOR ANY INDIRECT, SPECIAL, INCIDENTAL, OR CONSEQUENTIAL DAMAGES.

TI currently deals with a variety of customers for products, and therefore our arrangement with the user **is not exclusive.**

TI assumes **no liability for applications assistance, customer product design, software performance, or infringement of patents or services described herein.**

Please read the User's Guide and, specifically, the Warnings and Restrictions notice in the User's Guide prior to handling the product. This notice contains important safety information about temperatures and voltages. For additional information on TI's environmental and/or safety programs, please contact the TI application engineer or visit www.ti.com/esh.

No license is granted under any patent right or other intellectual property right of TI covering or relating to any machine, process, or combination in which such TI products or services might be or are used.

FCC Warning

This evaluation board/kit is intended for use for **ENGINEERING DEVELOPMENT, DEMONSTRATION, OR EVALUATION PURPOSES ONLY** and is not considered by TI to be a finished end-product fit for general consumer use. It generates, uses, and can radiate radio frequency energy and has not been tested for compliance with the limits of computing devices pursuant to part 15 of FCC rules, which are designed to provide reasonable protection against radio frequency interference. Operation of this equipment in other environments may cause interference with radio communications, in which case the user at his own expense will be required to take whatever measures may be required to correct this interference.

EVM WARNINGS AND RESTRICTIONS

It is important to operate this EVM within the input voltage range of 1.8 V to 4.5 V and the output voltage range of 2 Vrms.

Exceeding the specified input range may cause unexpected operation and/or irreversible damage to the EVM. If there are questions concerning the input range, please contact a TI field representative prior to connecting the input power.

Applying loads outside of the specified output range may result in unintended operation and/or possible permanent damage to the EVM. Please consult the EVM User's Guide prior to connecting any load to the EVM output. If there is uncertainty as to the load specification, please contact a TI field representative.

During normal operation, some circuit components may have case temperatures greater than 85°C. The EVM is designed to operate properly with certain components above 85°C as long as the input and output ranges are maintained. These components include but are not limited to linear regulators, switching transistors, pass transistors, and current sense resistors. These types of devices can be identified using the EVM schematic located in the EVM User's Guide. When placing measurement probes near these devices during operation, please be aware that these devices may be very warm to the touch.

Mailing Address: Texas Instruments, Post Office Box 655303, Dallas, Texas 75265
Copyright 2008, Texas Instruments Incorporated

IMPORTANT NOTICE

Texas Instruments Incorporated and its subsidiaries (TI) reserve the right to make corrections, modifications, enhancements, improvements, and other changes to its products and services at any time and to discontinue any product or service without notice. Customers should obtain the latest relevant information before placing orders and should verify that such information is current and complete. All products are sold subject to TI's terms and conditions of sale supplied at the time of order acknowledgment.

TI warrants performance of its hardware products to the specifications applicable at the time of sale in accordance with TI's standard warranty. Testing and other quality control techniques are used to the extent TI deems necessary to support this warranty. Except where mandated by government requirements, testing of all parameters of each product is not necessarily performed.

TI assumes no liability for applications assistance or customer product design. Customers are responsible for their products and applications using TI components. To minimize the risks associated with customer products and applications, customers should provide adequate design and operating safeguards.

TI does not warrant or represent that any license, either express or implied, is granted under any TI patent right, copyright, mask work right, or other TI intellectual property right relating to any combination, machine, or process in which TI products or services are used. Information published by TI regarding third-party products or services does not constitute a license from TI to use such products or services or a warranty or endorsement thereof. Use of such information may require a license from a third party under the patents or other intellectual property of the third party, or a license from TI under the patents or other intellectual property of TI.

Reproduction of TI information in TI data books or data sheets is permissible only if reproduction is without alteration and is accompanied by all associated warranties, conditions, limitations, and notices. Reproduction of this information with alteration is an unfair and deceptive business practice. TI is not responsible or liable for such altered documentation. Information of third parties may be subject to additional restrictions.

Resale of TI products or services with statements different from or beyond the parameters stated by TI for that product or service voids all express and any implied warranties for the associated TI product or service and is an unfair and deceptive business practice. TI is not responsible or liable for any such statements.

TI products are not authorized for use in safety-critical applications (such as life support) where a failure of the TI product would reasonably be expected to cause severe personal injury or death, unless officers of the parties have executed an agreement specifically governing such use. Buyers represent that they have all necessary expertise in the safety and regulatory ramifications of their applications, and acknowledge and agree that they are solely responsible for all legal, regulatory and safety-related requirements concerning their products and any use of TI products in such safety-critical applications, notwithstanding any applications-related information or support that may be provided by TI. Further, Buyers must fully indemnify TI and its representatives against any damages arising out of the use of TI products in such safety-critical applications.

TI products are neither designed nor intended for use in military/aerospace applications or environments unless the TI products are specifically designated by TI as military-grade or "enhanced plastic." Only products designated by TI as military-grade meet military specifications. Buyers acknowledge and agree that any such use of TI products which TI has not designated as military-grade is solely at the Buyer's risk, and that they are solely responsible for compliance with all legal and regulatory requirements in connection with such use.

TI products are neither designed nor intended for use in automotive applications or environments unless the specific TI products are designated by TI as compliant with ISO/TS 16949 requirements. Buyers acknowledge and agree that, if they use any non-designated products in automotive applications, TI will not be responsible for any failure to meet such requirements.

Following are URLs where you can obtain information on other Texas Instruments products and application solutions:

Products		Applications	
Amplifiers	amplifier.ti.com	Audio	www.ti.com/audio
Data Converters	dataconverter.ti.com	Automotive	www.ti.com/automotive
DSP	dsp.ti.com	Broadband	www.ti.com/broadband
Interface	interface.ti.com	Digital Control	www.ti.com/digitalcontrol
Logic	logic.ti.com	Military	www.ti.com/military
Power Mgmt	power.ti.com	Optical Networking	www.ti.com/opticalnetwork
Microcontrollers	microcontroller.ti.com	Security	www.ti.com/security
RFID	www.ti-rfid.com	Telephony	www.ti.com/telephony
Low Power Wireless	www.ti.com/lpw	Video & Imaging	www.ti.com/video
		Wireless	www.ti.com/wireless

Mailing Address: Texas Instruments, Post Office Box 655303, Dallas, Texas 75265
Copyright © 2007, Texas Instruments Incorporated